

System: Laufschiene eingenutet, keine Nut im Boden, ohne Blende, mit Clip-Laufwerk, für 2 Holztüren bis 16 kg. Design Infront

System: Top track, groove mounted, no groove in the floor, without fascia, with clip-on running gear, for 2 wooden doors up to 16 kg. Design Infront

Système: Rail de roulement dans rainuré, aucune rainure dans le sol, sans cache, avec chariot de roulement à clipsage, pour 2 portes en bois de 16 kg max. Design Infront

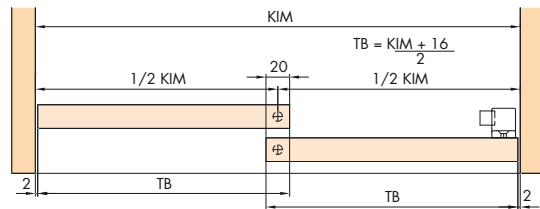
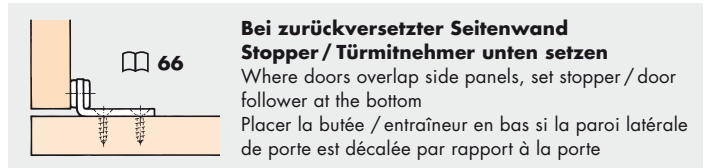
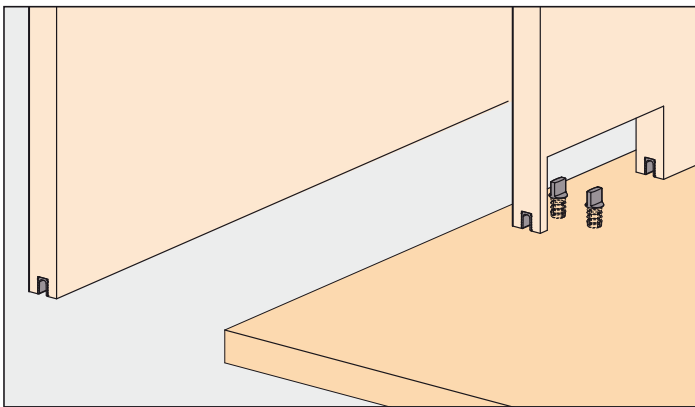

Einbaubeispiele / Mounting examples / Exemples de montage

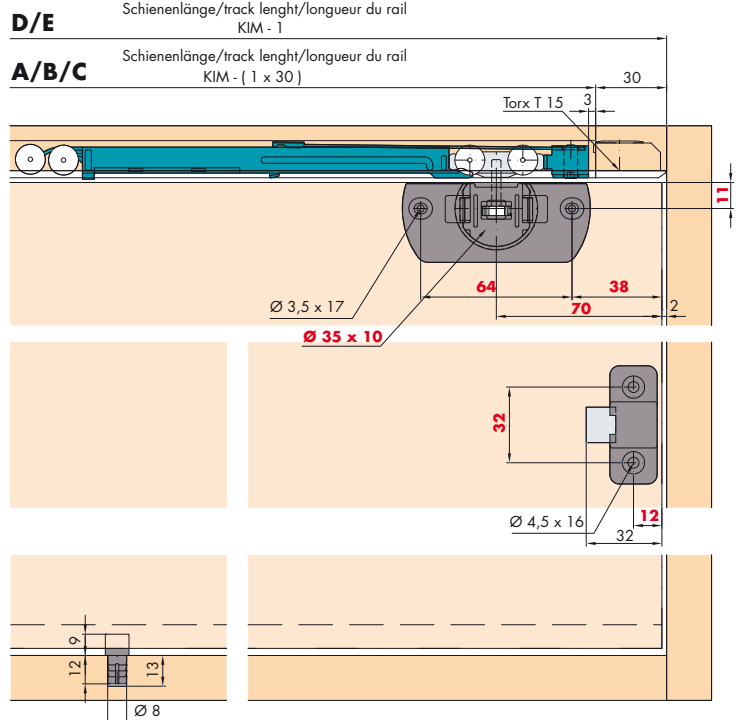
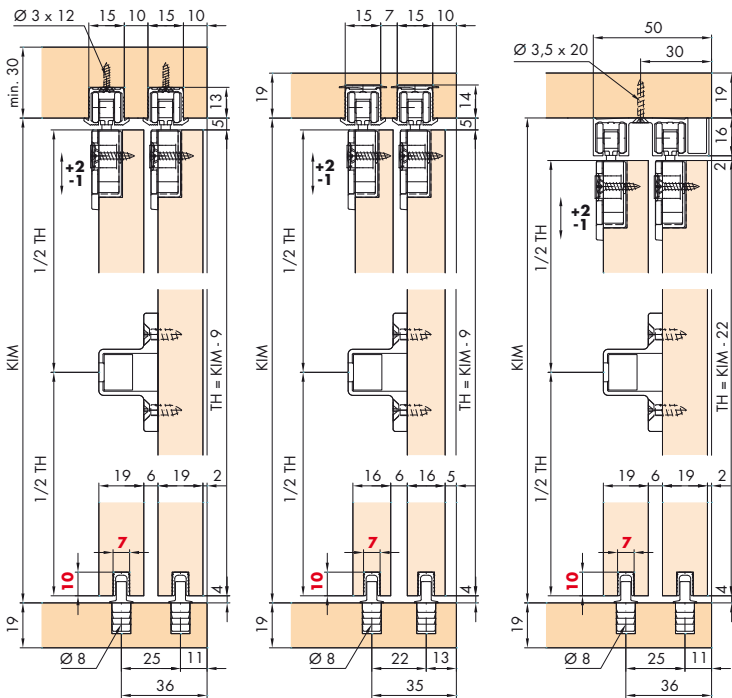

Türbearbeitung = rote Zahlen / Door treatment = red numbers / Traitement de portes = numéros en rouge
Dämpfung optional / Soft closing optional / Amortissement facultatif 64/65

Befestigungsvarianten/Mounting options/Variantes de fixation

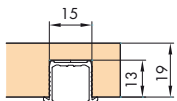

A zum Kleben
to glueing
à coller

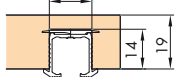

B mit Drehriegel (nicht für Hartholz/MDF)
with swivel lug (not for hard wood/MDF)
avec verrou (pas pour bois dur/MDF)

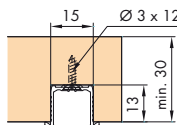

C zum Schrauben
screwed on
à visser

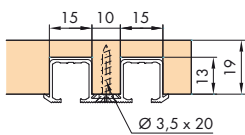

D zum Schrauben (nur für 19 mm Türen)
screwed on (19 mm doors only)
à visser (que portes 19 mm)

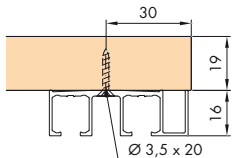

E zum Aufschrauben (nur für 19 mm Türen)
surface mounted (19 mm doors only)
à visser en applique (que portes 19 mm)



Türgewichte
Panel weights
Poids de portes **71**

Garnituren / Sets / Garnitures

2 Türen Doors Portes	No. 053.3220.071	
	4x	2x
	4x	2x
	1x	

Zubehör / Accessories / Accessoires

A Einfachlaufschiene Alu, zum Kleben

Single top track aluminium, for glueing
Rail de roulement simple en alu, à coller

Gr./Size	Art. No.
2500 mm	053.3229.250
3500 mm	053.3229.350
6000 mm	053.3229.600

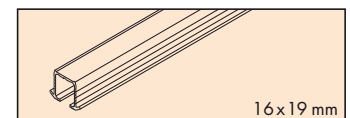

C Einfachlaufschiene Alu, gelocht, zum Schrauben

Single top track aluminium, pre-drilled, screwed on
Rail de roulement simple en alu, perforé, à visser

2500 mm	053.3225.250
3500 mm	053.3225.350
6000 mm	053.3225.600

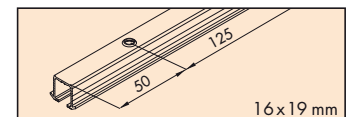

B Einfachlaufschiene Alu, mit Drehriegel (nicht für Hartholz/MDF)

Single top track aluminium, with swivel lug (not for hard wood/MDF)
Rail de roulement simple en alu, avec verrou (pas pour bois dur/MDF)

2500 mm	053.3227.250
3500 mm	053.3227.350
6000 mm	053.3227.600

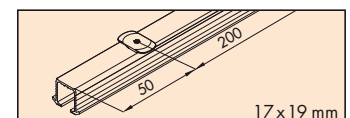

Schienenendstück, Kunststoff grau, mit Drehriegel (nicht für Hartholz/MDF)

Track-end piece, plastic grey, with swivel lug (not for hard wood/MDF)
Pièce d'extrémité, plastique gris, avec verrou (pas pour bois dur/MDF)

2x	053.3211.081
100x	053.3211.082

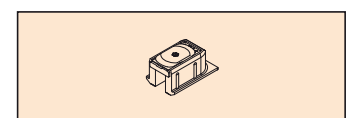

Schienenendstück, Kunststoff grau, zum Schrauben

Track-end piece, plastic grey, screwed on
Pièce d'extrémité, plastique gris, à visser

2x	053.3210.081
100x	053.3210.082

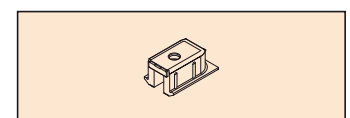

D Doppellaufschiene Alu, gelocht, zum Schrauben

Dual top track aluminium, pre-drilled, screwed on
Rail de roulement double en alu, perforé, à visser

2500 mm	053.3226.250
3500 mm	053.3226.350
6000 mm	053.3226.600

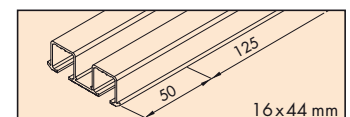

E Doppellaufschiene, Alu eloxiert, gelocht, zum Aufschrauben

Dual top track, aluminium anodized, pre-drilled, surface mounted
Rail de roulement double en alu, anodisé, perforé, à visser en applique

2500 mm	053.3231.250
3500 mm	053.3231.350
6000 mm	053.3231.600

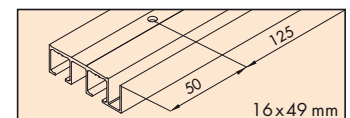

Führungsschiene, Kunststoff anthrazit, 7 mm

Guide track, plastic anthracite, 7 mm
Rail de guidage, en plastique anthracite, 7 mm

2500 mm	053.3012.250
3500 mm	053.3012.350
6000 mm	053.3012.600

